



PLUSI®

Fluid Handling Innovation

GENERAL FOLDER - 10.14



EXPLOSION
PROOF



FUEL
TRANSFER



GARAGE
EQUIPMENT



ADBLUE
SOLUTIONS

IT-EN-FR-DE-RU

IT. L'azienda

PIUSI nasce nel 1953 a Suzzara, in provincia di Mantova, come officina meccanica per applicazioni agricole che si è distinta per i prodotti resistenti e di facile utilizzo, adatti a PIU'-USI.

La costante ricerca per fornire soluzioni innovative, frutto del genio dell'eccellenza Italiana, ha portato PIUSI alla realizzazione di un'area produttiva, di un magazzino automatizzato e di moderni uffici pari a 25.000 m², inseriti in un'area di 44.000 m².

I valori che ci guidano

Qualità, riconosciuta dal mercato e da organismi internazionali che attestano sia l'affidabilità dei processi produttivi (UNI EN ISO 9001:2008) che l'attenzione per l'ambiente (UNI EN ISO 14001:2004).

I prodotti

PIUSI spa fornisce soluzioni professionali, di semplice utilizzo e di elevate prestazioni per il travaso, per il rifornimento e per la misurazione di lubrificanti, carburanti e liquidi.

EN. The company

PIUSI was established in 1953 in Suzzara, in the province of Mantua (Italy). They started as a mechanical engineering workshop serving the agricultural industry. The company soon made a name for itself as a manufacturer of strong and easy-to-use products suitable for a range of "different uses" (piu-usi).

Research is constantly focused on finding innovative solutions, the upshot of the genius of Italian excellence. This has led PIUSI to set up modern offices and a manufacturing facility which includes an automated warehouse on a covered surface area of 25,000 m² (270,000 SqFt), part of a larger area covering 44,000 m² (470,000 SqFt).

Our guiding values

Quality, recognised by the market and by international bodies which certify the reliability of production processes (UNI EN ISO 9001:2008) and environmental friendliness (UNI EN ISO 14001:2004)

Products

PIUSI spa provides professional, easy-to-use and top-performance solutions for transferring "dispensing" and measuring fuels, lubricants and liquids.

FR. L'entreprise

PIUSI a été fondée en 1953 à Suzzara, dans la province de Mantoue : il s'agissait d'un atelier mécanique fabriquant des applications agricoles, qui s'est aussitôt distingué pour ses produits robustes et faciles à utiliser, et surtout polyvalents (en italien, PIU'- USI).

La recherche constante visant à fournir des solutions innovantes, fruit du génie de l'excellence italienne, a mené PIUSI à réaliser une aire de production, un magasin automatisé et des bureaux modernes sur 25 000 m², le tout enchâssé dans un espace de 44 000 m².

Les valeurs qui nous guident

La qualité : reconnue par le marché et par des organismes internationaux qui attestent non seulement la fiabilité des processus de production (UNI EN ISO 9001:2008), mais aussi l'attention pour l'environnement (UNI EN ISO 14001:2004)

Les produits

PIUSI spa fournit des solutions professionnelles, simples à utiliser, mais aux performances élevées, pour le transvasement, le ravitaillement et la mesure de lubrifiants, carburants et liquides.

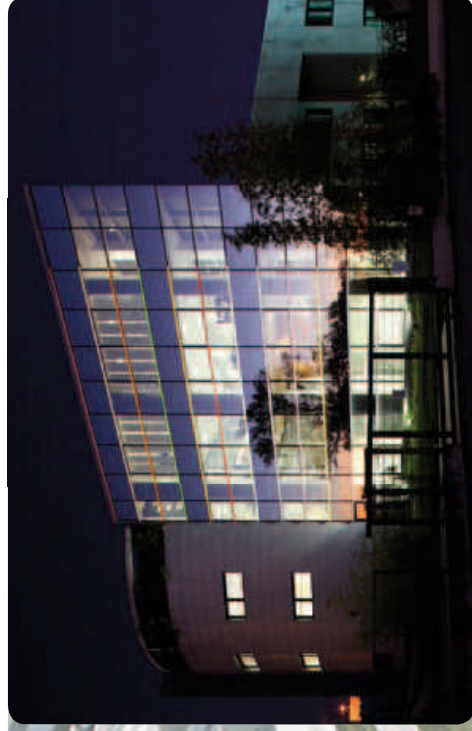

DE. Das Unternehmen

Gegründet wurde PIUSI 1953 in Suzzara in der Provinz Mantova als Werkstatt für Landmaschinen. Das Unternehmen zeichnete sich durch robuste, leicht einsetzbare und vielseitig verwendbare Produkte aus. Ständige Suche nach innovativen Lösungen, typisch für italienischen Forschergeist, hat dazu beigetragen, dass aus PIUSI eine Produktionsstätte mit automatischem Lagersystem, modernen Büros auf 25.000 m² auf einem 44.000 m² großen Gelände wurde.

Unsere Grundsätze

Qualität, von den Marken und internationalen Organisationen anerkannt, die die Zuverlässigkeit der Produktionsprozesse (UNI EN ISO 9001:2008) und den Umweltschutz (UNI EN ISO 14001:2004) bestätigen

Die Produkte

PIUSI spa liefert professionelle Lösungen, einfach anwendbar bei hoher Leistung für das Umfüllen, die Abgabe und die Messung von Schmier- und Kraftstoffen und Flüssigkeiten.

RU. Компания

Компания PIUSI была основана в 1953 г. в городе Суццара провинции Мантуя. Сначала это была механическая мастерская для сельскохозяйственных нужд, продукция которой отличалась стойкостью, простотой в применении и многофункциональностью (итал. PIU-USI).

Благодаря непрерывным исследованиям и разработкам инновационных решений, а также традиционному итальянскому стремлению к превосходству предприятие PIUSI со временем расширило производственную площадь, построило автоматизированный склад и современные офисы площадью 25 000 м² на территории 44 000 м².

Ценности, которыми мы руководствуемся

Качество нашей продукции получило признание как на рынке, так и в международных организациях, которые проводят аттестацию надежности производственных процессов (UNI EN ISO 9001:2008) и ответственного отношения к окружающей среде (UNI EN ISO 14001:2004).

Продукция

Акционерное общество PIUSI предлагает профессиональные, высокоэффективные и в то же время простые решения для перекачивания, заправки и измерения смазочных веществ, топлива и жидкостей.



EXPLOSION PROOF



PIUSI DRUM EX50



Flow rate up to 50 l/min (13 gpm)

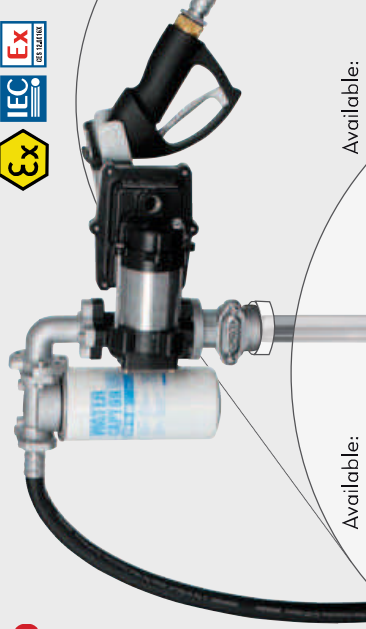

Available:



Water captor

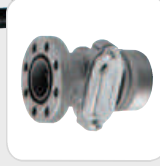

2" connector



K33 ATEX meter

Available:

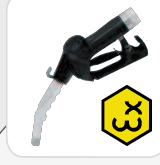

Automatic nozzle

Telescopic pipe

PIUSI EX50



Flow rate up to 50 l/min (13 gpm)

1" BSP



EX50 PUMP



REGISTERED DESIGN

EX50 GROUP

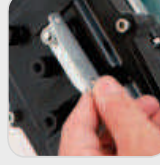

On/off switch



Flanged connection



Compact and sturdy construction

K33 ATEX



Flow rate up to 120 l/min (32 gpm)

Accuracy: +/- 1%

3,5 bar (50 psi)

1" BSP



Nutating disk system



K24 - ATEX / IECEx



Flow rate 7-120 l/min (2-32 gpm)

Accuracy: +/- 1%

Bidirectional



Rotable display

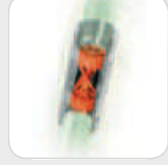

Turbine pulse meter

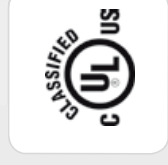

UL classified

REGISTERED DESIGN
PATENTED

SELF SERVICE K44

D B

Flow rate up to 90 l/min (24 gpm)

Accuracy: +/- 1 %



Filter integrated (column version)



Mechanical meter integrated

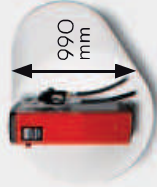

Tank version available



SELF SERVICE MC DB

Flow rate up to 90 l/min (24 gpm)

Accuracy: +/- 0.5 %

Users no. 80 max

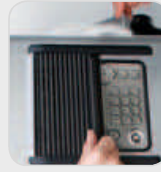

Display cover



Water captor filter



Self service desk software (available)

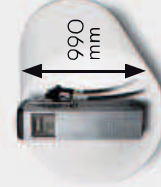

Tank version available

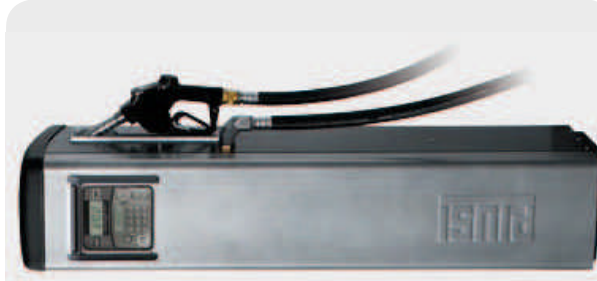

SELF SERVICE FM

D B

Flow rate up to 90 l/min (24 gpm)

Accuracy: +/- 0.5 %

Users no. 120 max



Ticket printer



Display cover



Self service desk software (available)



Water captor filter



Level indicator



Tank version available

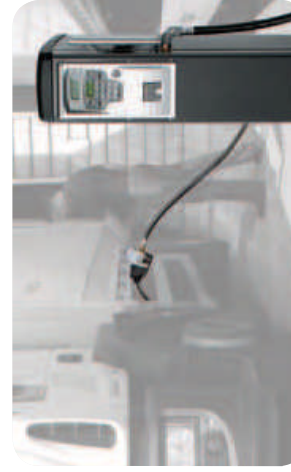
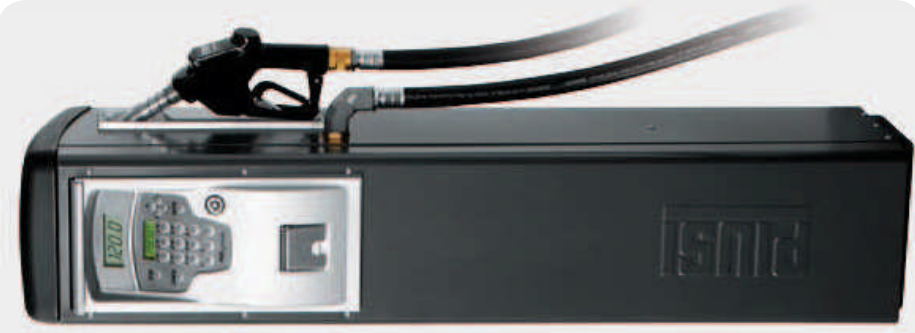

DISPENSERS

CUBE 56 - 70



Flow rate up to 70 l/min (18 gpm)

Accuracy: +/- 1%



Water captor (optional)



2" Drum connector (optional)

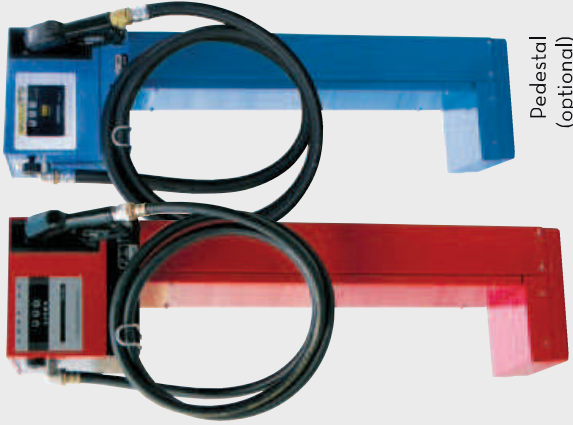

Pedestal (optional)

CUBE 70 MC D



Flow rate up to 70 l/min (18 gpm)



Accuracy: +/- 0,5%



Users no. 120 max



CUBE 70 MC LITE

Users no. 120 max

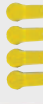

READY TO USE



CUBE MC PRESET available

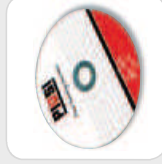

Self service desk software (optional)



PC CONNECTIONS

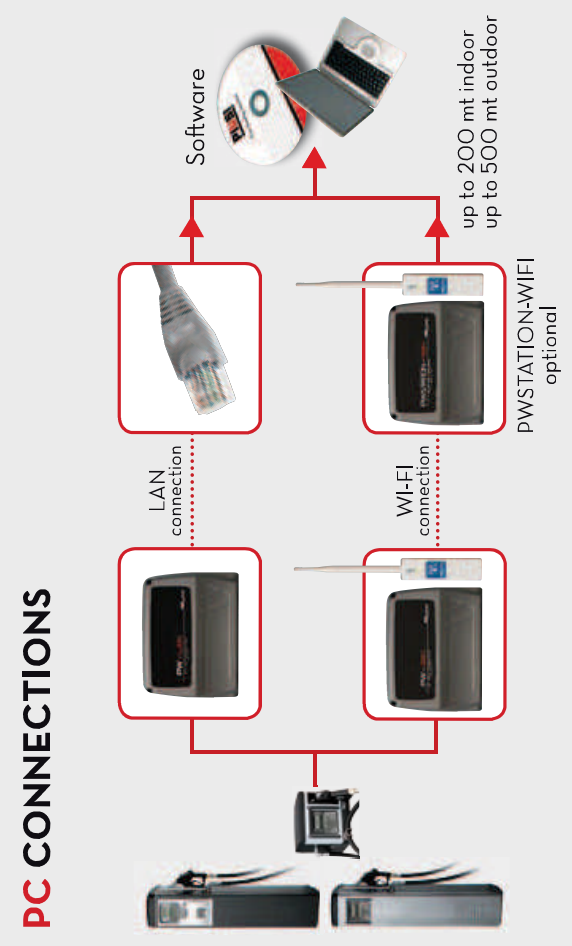

SELF-SERVICE DESK



Software

up to 200 mt indoor
up to 500 mt outdoor

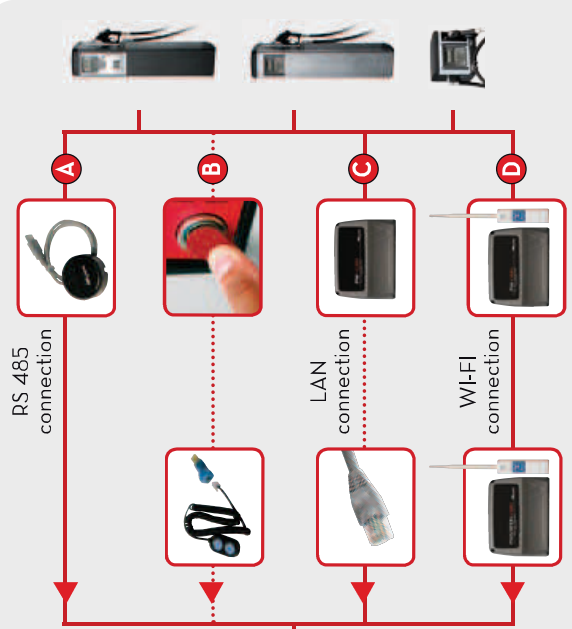

FLUID MONITORING



MC BOX SYSTEM

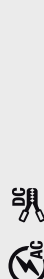

Users no. 120 max

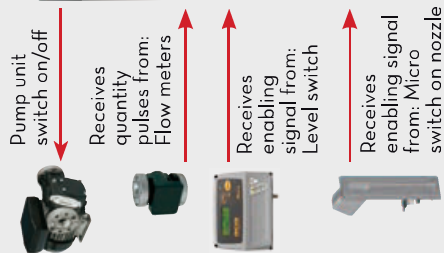

MC BOX PRESET WITH PULSEOUT

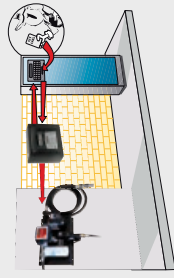

OCIO



up to 30 cst

Accuracy: +/- 1% (end of scale)

Fuel level
10mm
Measured resolution



Fuel volume
20 litres
Calculated resolution



Fuel %
1%
Calculated resolution

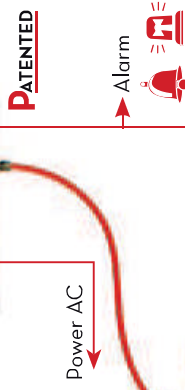

PATENTED



MC BOX LITE



READY TO USE

Users no. 20 max

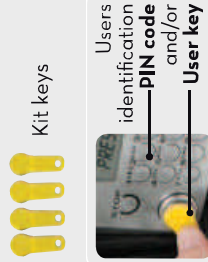

OCIO DESK SOFTWARE



OCIO GSM



EXPLOSION PROOF

FUEL TRANSFER

GARAGE EQUIPMENTS

ADBLUE SOLUTIONS

F LUID MONITORING

D ISPENSERS



SELF SERVICE 2.0

D B G K O U

EXISTING LAN NETWORK



HARDWARE 2.0



MAGNETIC KEY
(ON REQUEST)



User management



Vehicle management

WIFI
(ON REQUEST)

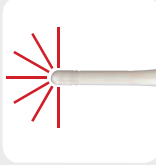

ST



Flow rate up to 90 l/min (24 gpm)

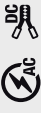
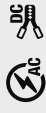

Accuracy: +/- 1 %



ST WITH METER



Flow rate up to 90 l/min (24 gpm)



Accuracy: +/- 1 %



ACCESS 85

D B G K O

Users no. 85 max



Emergency button

Functional led

Start and stop button

Key reader



OCIO Level control

Nozzle switch control

ST WITH METER + FILTER



Flow rate up to 85 l/min (22 gpm)



Accuracy: +/- 1 %



Suction hose



Water captor filter



Meter K33



Automatic nozzle



Clear captor filter

DRUM DBO

Flow rate up to 80 l/min (21 gpm)

Accuracy: +/- 1 %

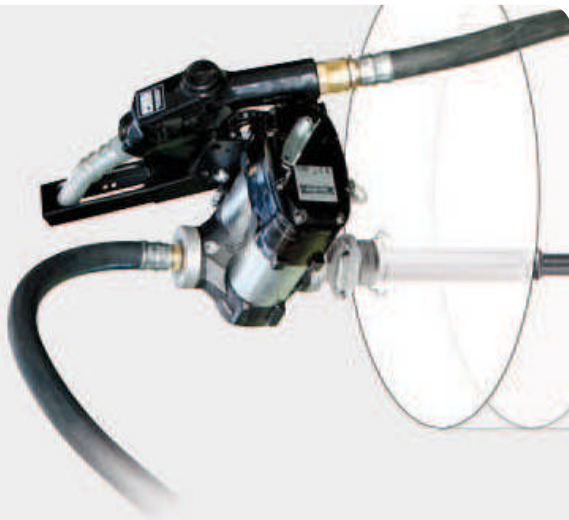

Drum with meter



Drum Kit available



ST BOX D

Flow rate up to 85 l/min (22 gpm)

Accuracy: +/- 1 %



Water captor

ST 200 DC D

Flow rate up to 185 l/min (48 gpm)

24 V



ST 200 AC D

Flow rate up to 200 l/min (52,7 gpm)

230 V

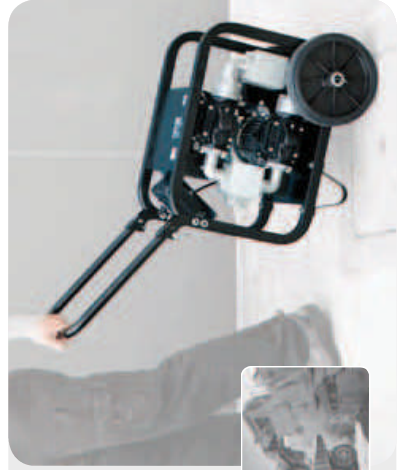

PIUSI PITSTOP DC D

Flow rate up to 45 l/min (15 gpm)

12 V 24 V

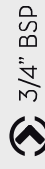

AUTOMATIC HOSE REEL

READY TO INSTALL



Automatic nozzle



Built in DC pumps



14 m hose



DISPENSERS

PIUSI BOX

Flow rate up to 45 l/min (11,9 gpm)
12 V 24 V



REGISTERED DESIGN
PATENT PENDING

NOZZLES

MANUAL NOZZLE

Flow rate up to 150 l/min (40 gpm)



Swivel



BATTERY KIT

Flow rate up to 50 l/min (10 gpm)
12 V 24 V

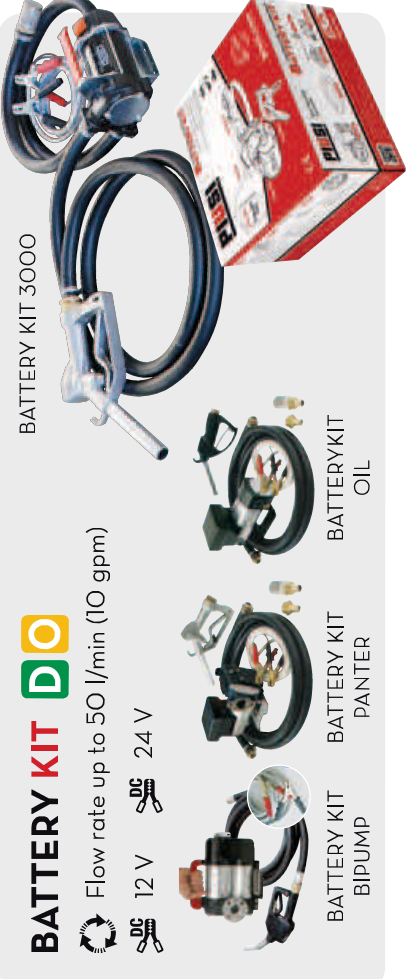

BATTERY KIT 3000

BATTERY KIT
BIPUMP

BATTERY KIT
PANTER

BATTERYKIT
OIL

PICO

Flow rate up to 35 l/min (9 gpm)



Base version
without meter



Version
with meter

EXPLOSION PROOF

FUEL TRANSFER

GARAGE EQUIPMENTS

ADBLUE SOLUTIONS



AUTOMATIC NOZZLE

Flow rate up to 280 l/min (74 gpm)



Automatic stop



HOSEREEL AUTOMATIC

1" male BSP 10 bar (145 psi)

AUTOMATIC HOSE REEL

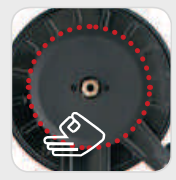

Hand
protections



Hosereel
without hose



Hosereel
with hose

PUMPS



PANTHER 56 - 72

Flow rate up to 72 l/min (19 gpm)

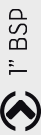
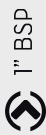

Filter

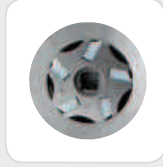

Vane rotors

PANTHER 72

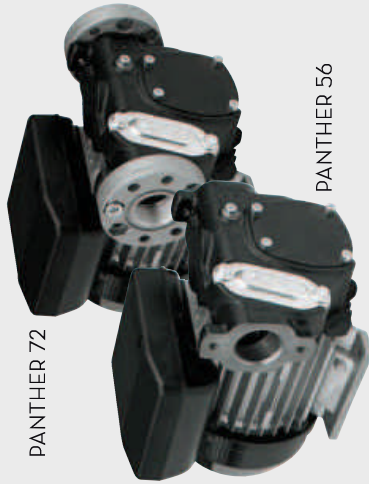

PANTHER 56

E80 - E120

Flow rate up to 100 l/min (26 gpm)

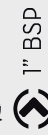

VISCOMAT VANE

Flow rate up to 50 l/min (13 gpm)

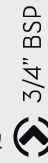
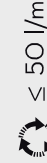

BP3000 - BP3000 INLINE

Flow rate up to 50 l/min (13 gpm)



3/4" BSP



CARRY

Flow rate up to 50 l/min (13 gpm)



REGISTERED DESIGN

PATENTED

VANTAGE 60

Flow rate up to 60 l/min (15,9 gpm)



PC interface



VANTAGE 100

Flow rate up to 100 l/min (26 gpm)



Vantage

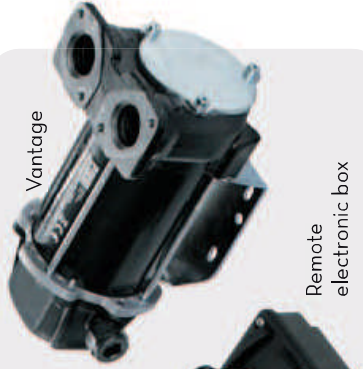

Remote electronic box



HAND PUMPS



45 l/min (11 gpm)

40 l/min (10 gpm)

60 l/min (16 gpm)

25 l/min (7 gpm)

35 l/min (9 gpm)

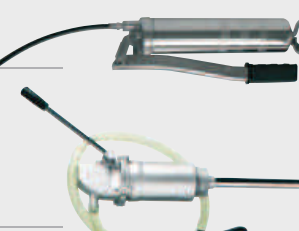

PANTER DC

Flow rate up to 70 l/min (18,5 gpm)



1" BSP



BIPUMP

Flow rate up to 85 l/min (22,4 gpm)



1" BSP



EXPLOSION PROOF

FUEL TRANSFER

GARAGE EQUIPMENTS

ADBLUE SOLUTIONS

FLOW METERS



MECHANICAL METER
K33 - K44

DBO

Flow rate 20-120 l/min (5-32 gpm)
Accuracy: +/- 1%

ELECTRONIC METER
K600 B/3

DBO

Flow rate up to 100 l/min (26,4 gpm)
Accuracy: +/- 0,5%

PATENTED

ELECTRONIC METER
K400

DBO

Flow rate up to 30 l/min (7,9 gpm)
Accuracy: +/- 0,5%

REGISTERED DESIGN

DIGITAL TURBINE METER
K24

ADFGK UW

Flow rate 7-120 l/min (2-32 gpm)
Accuracy: +/- 1%

PATENTED

Rotable display

Bidirectional

REGISTERED DESIGN

ELECTRONIC METER
K600/3

ABDO

Flow rate up to 100 l/min (26,4 gpm)
Accuracy: +/- 0,5%

PATENTED

ELECTRONIC METER
K600/4

ABDO

Flow rate up to 150 l/min (39 gpm)
Accuracy: +/- 0,5%

PATENTED

MECHANICAL METER
K700

D

Flow rate 20-220 l/min (5-53 gpm)
Accuracy: +/- 1%

ELECTRONIC METER
K200

ABDGO

Flow rate up to 2,5 l/min (0,66 gpm)
Accuracy: +/- 0,5%

ELECTRONIC METER
NEXT/2

O

Flow rate up to 60 l/min (15,8 gpm)
Accuracy: +/- 0,5%

	bar (psi)	BSP
K33 - K44	10 (142)	1"
K24	20 (300)	1"
K700	10 (142)	1" 1/2
K200	500 (7200)	1/4"
K200 HP	1000 (14500)	1/8"
K600/3	70 (994)	3/4" - 1"
K600/4	20 (284)	1" 1/2
K400	70 (994)	1/2"
NEXT/2	70 (994)	3/4"

EXPLOSION PROOF

FUEL TRANSFER

GARAGE EQUIPMENTS

ADBLUE SOLUTIONS

PULSE-METERS



PULSE-METERS **A B D G O W**

Flow rate up to 150 l/min (39 gpm)

Accuracy: +/- 0,5 %



Oval gear



K2000 HP

1/8" BSP



K400

1/2" BSP



K24 turbine meter

1" BSP



K600/3

3/4" - 1" BSP



K600/4

1" 1/2 BSP

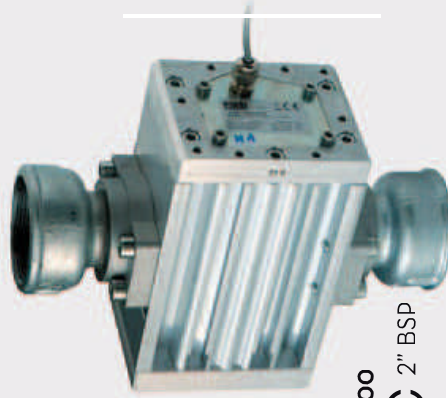

K700

2" BSP

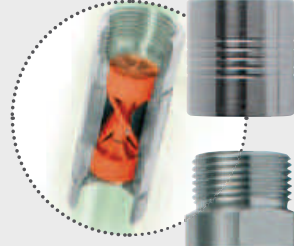

TURBINOX INLINE

1" BSP

1" BSP

K900 **A B D O**

Flow rate up to 500 l/min (132 gpm)

Accuracy: +/- 0,5 %



Oval gear



K900

3" BSP

REMOTE DISPLAY FOR PULSE METER



EXPLOSION PROOF

FUEL TRANSFER

GARAGE EQUIPMENTS

ADBLUE SOLUTIONS

ACCESSORIES

FILTERING



EXPLOSION PROOF

FUEL TRANSFER

GARAGE EQUIPMENTS

ADBLUE SOLUTIONS

COUPLING, FITTINGS AND FLANGED CONNECTIONS

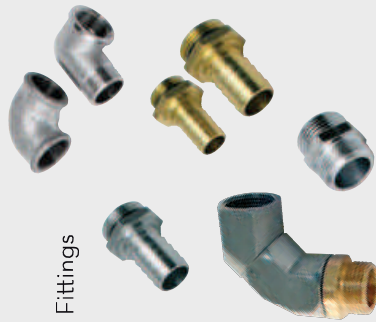

Fittings

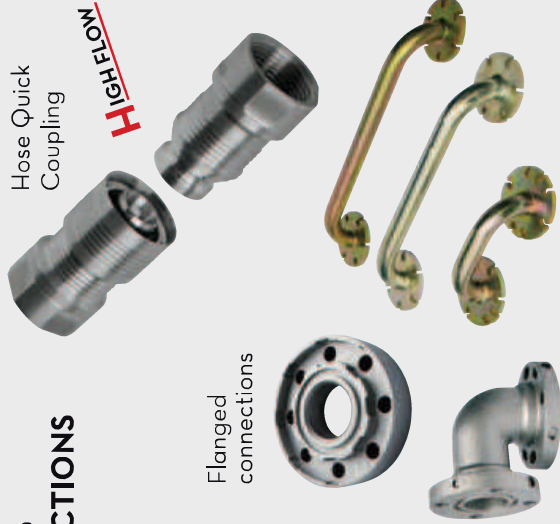

Hose Quick Coupling

HIGHFLOW

Flanged connections

FILTROLL



Flow rate up to 56 l/min (15 gpm)



Filtroll Diesel

Filtroll Oil/Diesel

Two step filtration

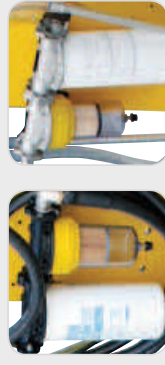

Diesel version

Oil/diesel version

CONNECTORS



Fittings

CONNECTORS

Extensible steel pipe

2" quick coupling

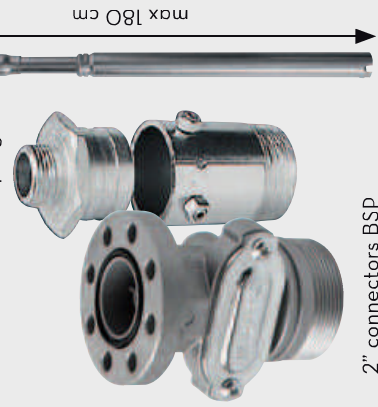

2" connectors BSP

max 180 cm

FOOT VALVE



1" BSP



Foot valve with filter

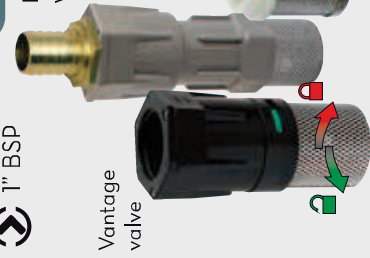

Vantage valve

Foot filter

PATENTED

DEPUROIL



Flow rate up to 25 l/min (6,6 gpm)

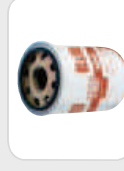
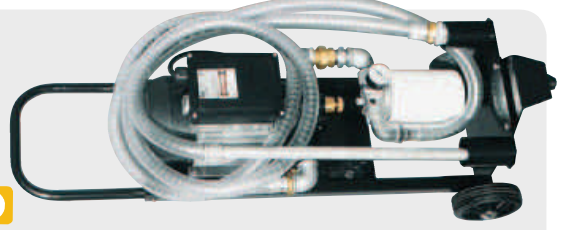

Cartridge



Foot filter

LINE FILTER 1-1



F/F, flanged 1" BSP

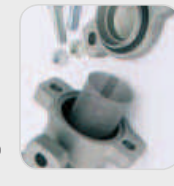

FILTERS

FILTERS



Flow rate
up to 150 l/min
(39,6 gpm)



Clear Captor filter
100 l/min



Water Captor
70 l/min
with water
absorbing



Clear Captor strainer
100 l/min



Water Captor
150 l/min
with water
absorbing



Clear Captor water filter
with water absorbing
70 l/min



Bio-fuel filter
100 l/min
with water
absorbing



Bio-fuel filter
70 l/min
with water
absorbing



Oil and fuel filter 100 l/min



Oil and fuel filter 60 l/min



DISPENSERS

DRUM VISCOMAT



Flow rate up to 25 l/min (7 gpm)
Accuracy: +/- 0,5 %
up to 2000 cSt

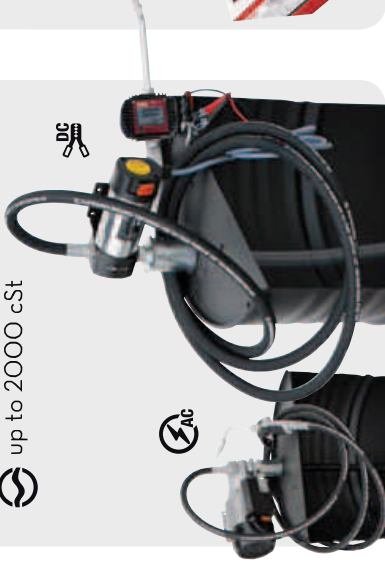

BATTERY KIT OIL



Flow rate up to 10 l/min (3 gpm)
up to 600 cSt
12 V 24 V



VISCOTROLL AC



Flow rate up to 25 l/min (7 gpm)
Accuracy: +/- 0,5 %
up to 2000 cSt



Drum not included

VISCOTROLL DC



Flow rate up to 6 l/min (1,6 gpm)
Accuracy: +/- 0,5 %
up to 2000 cSt



Drum not included

PUMPS

VISCOMAT GEAR

- ≤ 14 l/min (3,7 gpm)
- 1" BSP
- ≤ 2000 cSt
- ≤ 25 bar (362 psi)



VISCOMAT VANE

- ≤ 50 l/min (13 gpm)
- 3/4" BSP
- ≤ 500 cSt
- ≤ 6 bar (87 psi)



VISCO-FLOWMAT

- ≤ 14 l/min (3,7 gpm)
- ≤ 2000 cSt
- ≤ 25 bar (362 psi)
- 1" BSP

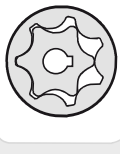
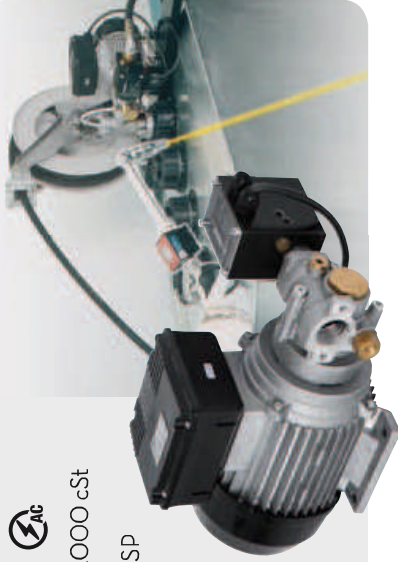

Gear rotors

Adjustable max delivery pressure

VISCOMAT DC

- Flow rate up to 10 l/min (2,8 gpm)
- up to 2000 cSt
- 1/2" - 3/4" BSP

VISCOMAT DC 60/2
VISCOMAT DC 120/1



Gear rotors

VISCOMAT DC 60/1

NOZZLE METERS

K500 PRESET

- Flow rate up to 30 l/min (7,8 gpm)
- Accuracy: +/- 0,5 %
- up to 2000 cSt
- 1/2" BSP



High protection



Sealed battery compartment



75°

Automatic no drip valve

K40

OB

- Flow rate up to 30 l/min (7,8 gpm)
- Accuracy: +/- 1 %
- up to 2000 cSt
- 1/2" BSP



K40 meter + nozzle + flexible extension



Mechanical counter



Meter with oval gears



GREASTER

- ≤ 2,5 kg/min
- ≤ 550 bar (7975 psi)
- +/- 3 %
- 1/4" - 1/8" BSP



Multifunction display



Meter with oval gears

GREASTER nozzle
+ rigid spout
+ Z swivel



K400 meter
+ nozzle
+ flexible extension

K400

- Flow rate up to 30 l/min (7,8 gpm)
- Accuracy: +/- 0,5 %
- up to 2000 cSt
- 1/2" BSP



Multifunction display



NEXT/2

- Flow rate up to 60 l/min (15 gpm)
- Accuracy: +/- 0,5 %
- 3/4" BSP



Meter with oval gears



Semi-automatic no drip valve



NOZZLE METER NEXT/2
+ rigid extension

NOZZLE METER NEXT/2
+ flexible extension

EASYOIL

- Flow rate up to 30 l/min
- Work pressure 70 bar
- 1/2" BSP



Trigger lock



Filter

EASY OIL nozzle
+ swivel
+ flexible spout

Pistol-ONE

- Flow rate up to 90 l/min (23,8 gpm)
- Work pressure 100 bar
- 3/4" BSP

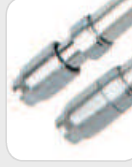

Semi-automatic no drip valve

Pistol-ONE
+ rigid spout

SPECIAL EQUIPMENTS

VACUBOX



FULLY AUTOMATIC



Flow rate up to 10 l/min (3 gpm)

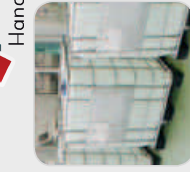
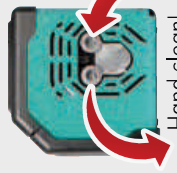

Direct into waste oil storage tank



Suction



OIL MONITORING SYSTEM

MCO SYSTEM



Users up to 900

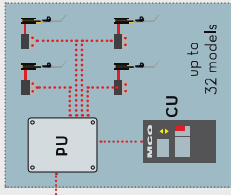
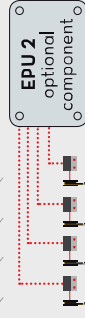
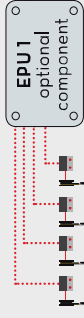

WI-FI CONNECTION (available)

LAN CONNECTION (available)



CAMBIAOLIO



Portable oil charger

Flow rate up to 10 l/min (3 gpm)

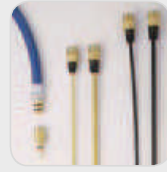

Probe Kit



Pressure Gauge



Tank 12 liter

EASY TO USE

EXPLOSION PROOF

FUEL TRANSFER

GARAGE EQUIPMENTS

ADBLUE SOLUTIONS

GPV



Flow rate up to 30 l/min (7,9 gpm)
Accuracy: +/- 0,5 %



Valve



Filter



Oval gears

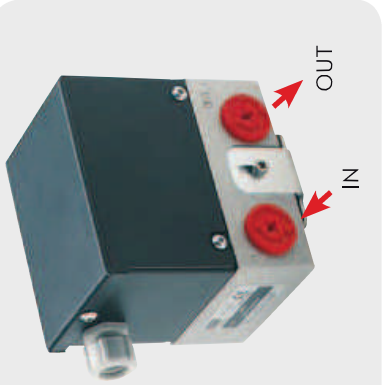

AMALFI



AMALFI 5

≤ 34 l/min (9 gpm)
1/2" BSP



AMALFI 1

GARDA



GARDA 5

≤ 10 l/min (2,6 gpm)
3/8" BSP



GARDA 1

GARDA 2

OCIO



PATENTED



up to 30 cst
Accuracy: +/- 1 % (end of scale)



OCIO desk



OCIO gsm



DISPENSERS AND PUMPS



Flow rate up to 35 l/min (9 gpm)



Pico 12 V DC
+ k24 meter
+ manual nozzle



Pico 12 V DC
+ k24 meter
+ manual nozzle



SuzzaraBlue
DC pump



SuzzaraBlue
AC pump

DUMBOX



Container and Funnel



Flexible

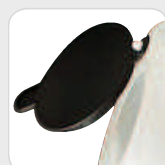

Cap

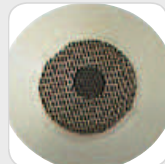

Inbuilt filter



NOZZLES AND METERS



Flow rate up to 120 l/min (30 gpm)
Accuracy: +/- 0,5 %



Oval gears



Rotable display



K24 turbine digital meter



Easy windscreen
with K400
meter

Easy
windscreen

DISPENSERS

SUZZARABLU DELPHIN

AdBlue® car dispenser



AC Pump



Fitting Valve

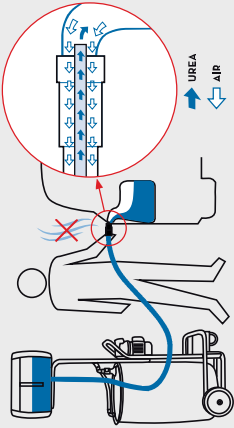

CLOSED SYSTEM

PATENT PENDING

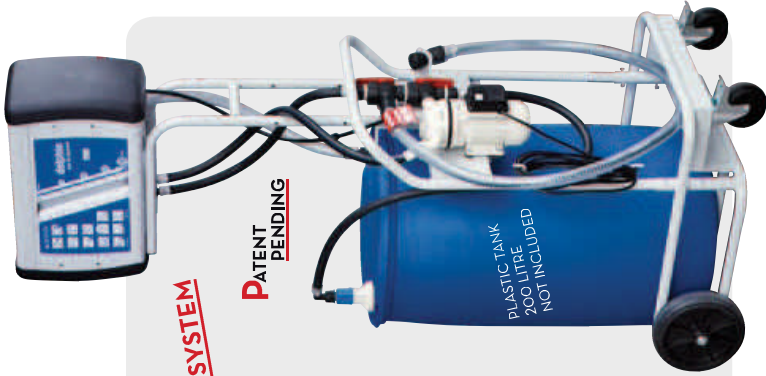

PLASTIC TANK
200 LITRE
NOT INCLUDED

SUZZARABLU SIDE

Flow rate up to 32 l/min (8,5 gpm)

Accuracy: +/- 1%



SEC connection

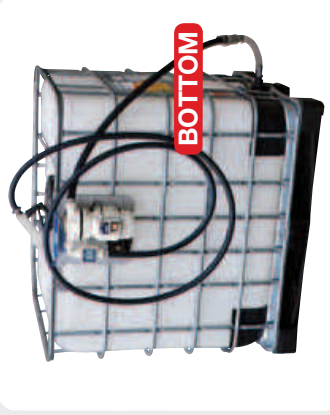

SUZZARABLU EXTERNAL SUCTION

SUZZARABLU BASIC



SUZZARABLU PRO (K24+SB325 nozzle)

PIUSI THREE25

Accuracy: +/- 1%



TURN KEY SYSTEM

100% MADE IN ITALY



New Safety lock bracket system



AdBlue® long life 3D Filter



Sturdy Stainless Steel Plate



Crimped EPDM delivery hose



SUZZARABLU BOX

Flow rate up to 32 l/min (8,3 gpm)

Accuracy: +/- 1%



K24 meter



Automatic nozzle



Hose and foot valve

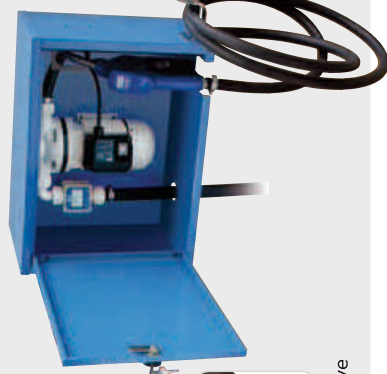

SUZZARABLU EXTERNAL SUCTION

EXPLOSION PROOF

FUEL TRANSFER

GARAGE EQUIPMENTS

ADBLUE SOLUTIONS

PUMPS



SUZZARABLU TROLL

 Flow rate up to 32 l/min (8,5 gpm)



Troll



Side

On request:

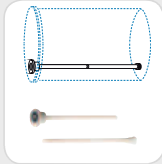

Dip tube



SUZZARABLU PUMPS

 Flow rate up to 36 l/min (9,2 gpm)



DC PUMPS 



REGISTERED DESIGN

On/off switch

AC PUMPS 



SUZZARABLU DRUM

 Flow rate up to 32 l/min (8,5 gpm)



Manual nozzle



SEC connection

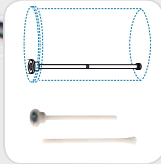

Dip tube

Available with:

SB325 SB325 METER



PIUSI HAND PUMPS

Capacity up to 38 L (10 USG) per 100 revolutions



Drum connector



Suction pipe



Stainless steel spout



SUZZARABLU PORTABLE KIT

 Flow rate up to 35 l/min (9,2 gpm)

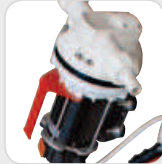

DC pump



Clamps



Foot valve



SUZZARABLU HAND PUMPS

Piston hand pump (with complete kit)



Piston hand pump



Rotative hand pump (with complete kit)



Rotative hand pump



EXPLOSION PROOF

FUEL TRANSFER

GARAGE EQUIPMENTS

ADBLUE SOLUTIONS

METERS AND PULSE METERS

K24 UAWW

Flow rate up to 100 l/min (26,4 gpm)

Accuracy: +/- 1%

1" BSP

ON REQUEST:



Plastic fitting



Pulser version



Socket 1" BSP/BSP



K24 METER Rotable display

EXPLOSION PROOF

FUEL TRANSFER

GARAGE EQUIPMENTS

ADBLUE SOLUTIONS

NOZZLES

SUZZARABLU AUTOMATIC NOZZLES UAWW

Flow rate up to 35 l/min (9 gpm)



STAINLESS-STEEL SPOUT



SB325 AUTOMATIC NOZZLE



SB325 METER AUTOMATIC NOZZLE



BREAK-AWAY SYSTEM

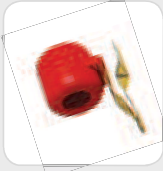

Piusi magnetic adaptor



Misfilling Kit Spout

EXPLOSION PROOF

FUEL TRANSFER

GARAGE EQUIPMENTS

ADBLUE SOLUTIONS



SUZZARABLU NOZZLES UAWW

Flow rate up to 80 l/min (21,1 gpm)



INOX AUTOMATIC NOZZLE



MANUAL NOZZLE

TURBINOX UAWW

Flow rate up to 40 l/min (10,6 gpm)

ON REQUEST:

Remote display

ACCESSORIES



HOSEREEL AUTOMATIC



Hosereel without hose

AUTOMATIC HOSE REEL



Hosereel with hose



Hand protections

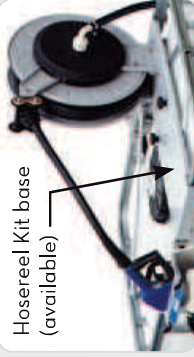

Hosereel Kit base (available)

CONNECTIONS + FITTINGS



Suction connections SEC

Gravity Kit

Plastic fitting

Kit bottom connection

EPDM Kit suction hose

A	ANTIFREEZE	IT. Anticongelante FR. Antigel	DE. Frostschutzmittel RU. Антифриз
B	BIODIESEL (B20 with concentration up to 20% in diesel)	IT. B20 con concentrazione fino al 20% nel diesel FR. B20 avec une concentration jusqu'au 20% dans le gasoil	DE. bis zu 20% B20 in Die selkraftstoffen RU. B20 с концентрацией до 20% в дизельном топливе
D	DIESEL	IT. Gasolio FR. Gasoil	DE. Diesel RU. Дизельное топливо
F	FOOD	IT. Alimenti FR. Nourriture	DE. Lebensmittel RU. Продукты питания
G	GASOLINE	IT. Benzina FR. Essence	DE. Benzin RU. Бензин
G^R	GREASE	IT. Grasso FR. Graisse	DE. Schmierfett RU. Консистентная смазка
K	KEROSENE	IT. Cherosene FR. Kérosène	DE. Kerosin RU. Керосин
O	OIL	IT. Olio FR. Huile	DE. Öl RU. Масло
U	ADBLUE	IT. AdBlue®/Aus32/ DEF/Arla32 FR. AdBlue®/Aus32/ DEF/Arla32	DE. AdBlue®/Aus32/ DEF/Arla32 RU. AdBlue®/Aus32/ DEF/Arla32
W	WATER	IT. Acqua FR. Eau	DE. Wasser RU. Вода
W	WINDSCREEN	IT. Liquido lavavetri FR. Liquides essuie-glaces	DE. Windschutzscheibenreiner RU. Жидкость для мытья лобового стекла

EXPLOSION PROOF

FUEL TRANSFER

GARAGE EQUIPMENTS

ADBLUE SOLUTIONS